

# AI4GOV

Public service @ your fingertips



## Bridging citizens and local governments

AI4GOV is a govtech startup dedicated to improve public services and promote citizen participation

YOUTH  
CO:LAB

Project Co-Leads



Citi Foundation



Empowered lives.  
Resilient nations.



AIM-DADO BANATAO  
INCUBATOR



CALABARZON



NATIONAL  
PRIVACY  
COMMISSION

# Digital

# Bayan

# Bot



a participatory channel for local development

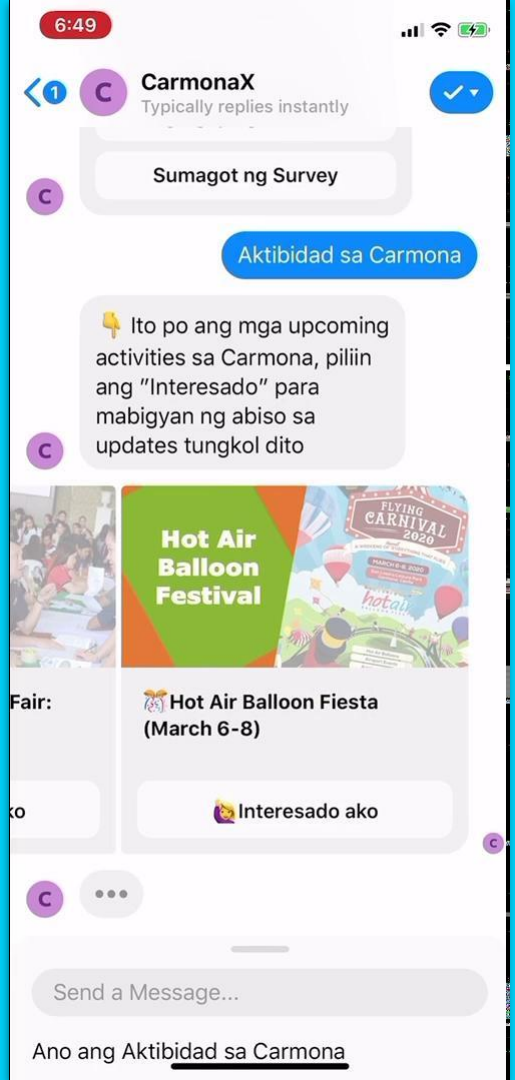

# TEST PERFORMANCE

## System Usability Survey

$$\overline{SUS} = \frac{1}{n} \sum_{i=1}^n \text{norm.} \sum_{j=1}^m \begin{cases} q_{i,j-1}, q_{i,j} \text{ mod } 2 > 0 \\ 5 - q_{i,j}, \text{ otherwise.} \end{cases}$$

Result: Excellent



83

Among users with access to gadget and internet / free data

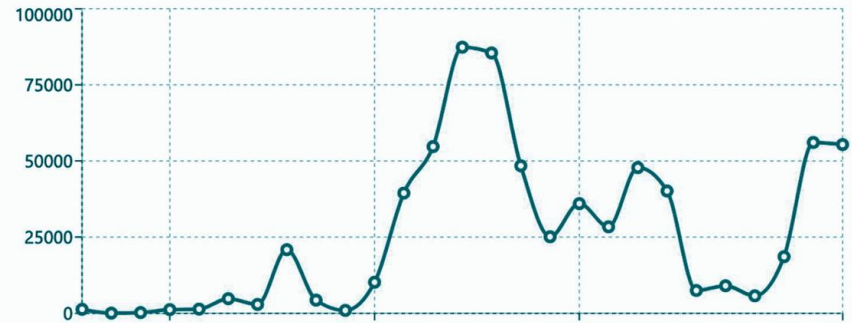
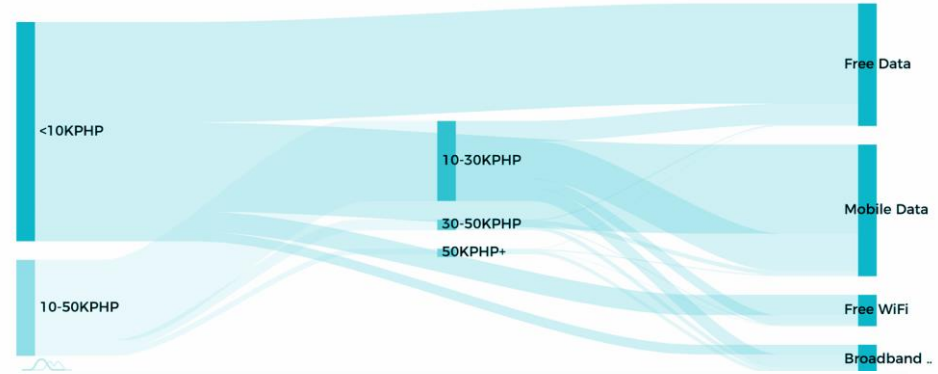

Overall Total: 3.5M interactions

# K.I.R.A

# Kontra

# COVID



COVID-19 Digital Triage and Information System

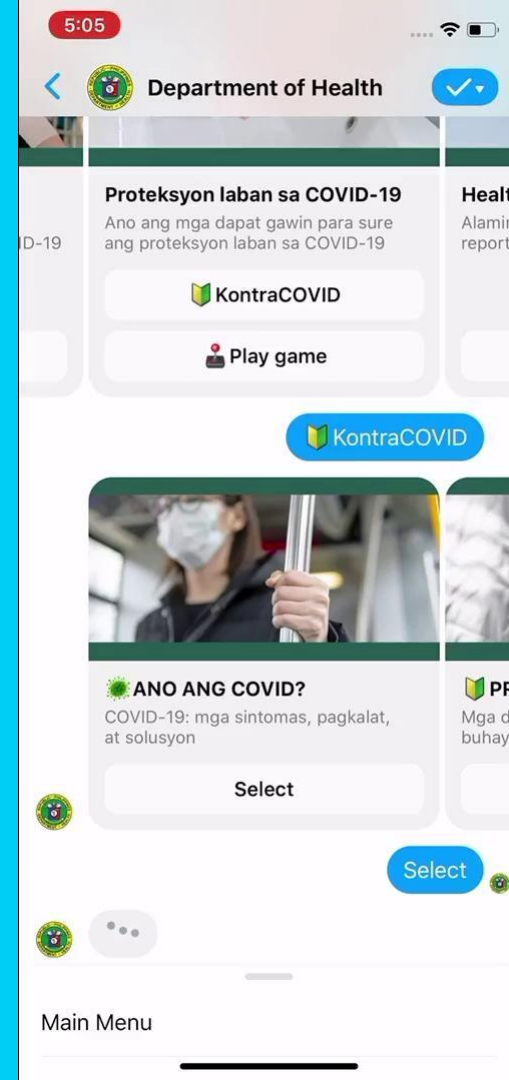

Citizen report via SMS @

via Chat @ Fb or Viber



**UBO**

**HIRAP SA PAGHINGA**

**LAGNAT**

**MAY SINTOMAS KA BA? MAG-TEXT NA!**

Kung gusto mong maka-sigurado, ipagbigay alam ang iyong sintomas sa inyong LGU nang mabigyang atensyon.

Mag-text ng REG <tirahan>, <bilang ng tao sa bahay> sa

**Globe users: 2158 5779**  
**Non-Globe: 225 655 779**

(Halimbawa: REG J.P. Rizal, Makati City, 5)



## CHAT WITH KIRA KONTRA COVID BOT

by the Department of Health



- ✓ Self-check
- ✓ Fact check
- ✓ News & Updates

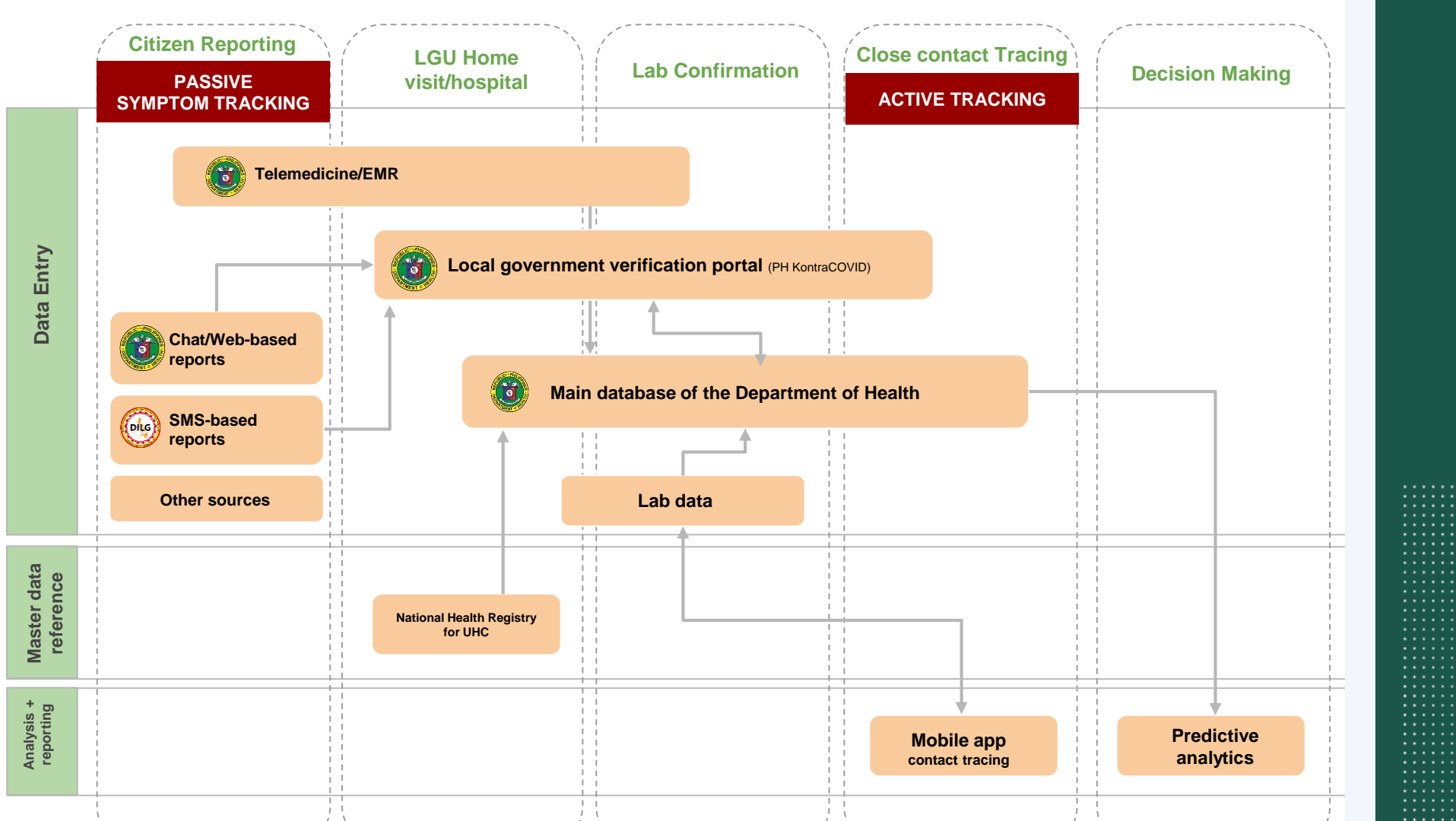



# LGU portal

SMS / Chat / Web reports are linked to KontraCOVID LGU portal

- LGU gets **notified** whenever there are new case reports or user-updated cases

- LGU can filter cases per barangay

The screenshot displays the PH KONTRA COVID BETA interface. At the top right, it shows the user profile 'DOHS User'. The main dashboard features a 'Toggle Filters' bar and five summary cards:



- COVID-19 Confirmed:** 1 (Verified 0%)
- Reported Suspect Severe:** 1669 (Verified 0%)
- Reported Suspect Mild:** 1089 (Verified 0%)
- Reported Probable:** 22 (Verified 0%)
- Low Risk for Covid:** 3557 (Population Proportion 0.00%)

A notification list is overlaid on the dashboard, showing three alerts:

- New Low Risk Report:** A 31 y/o Female reported her symptoms. Wed Aug 19 2020, 12:31:42 PM
- New Suspect - Severe Report:** A 0 y/o Female reported her symptoms. Wed Aug 19 2020, 10:03:05 AM
- TanodCovid Self Update:** Somebody updated his/her symptoms. Tue Aug 18 2020, 9:29:18 AM

The notification list includes a 'Mark All As Read' button at the bottom. Other visible elements include a 'QC Tester' profile, an 'Exposure' donut chart showing 168, and a sidebar with navigation options like Dashboard, Case Management, Maps, and Trace List.

# Integration from different data sources of contact tracing

PH KONTRA COVID BETA754NCR Admin

Dashboard

Case Management

Workplaces Surveillance

SMS

COVID-19 Tracker

Maps

## Case Management

Add Filter

Case ID

Searching by: Case ID

View Archived

0 filters added

☐	ID	👤	Last User Update MM/DD/YYYY	Date Submitted MM/DD/YYYY	👇	Status	👆	Case Investigator Action	Classification	Actions
☐	90136	👤	10/31/2020	10/26/2020	For Verification	No Case Assessment	👁️ 💬			
☐	90139	🏢	10/27/2020	10/26/2020	For Verification	Low Risk with ARI	👁️ 💬			
☐	90123	👤	10/26/2020	10/02/2020	For Verification	No Case Assessment	👁️ 💬			
☐	90120	👤	10/26/2020	10/02/2020	For Verification	No Case Assessment	👁️ 💬			
☐	90131	👤	10/24/2020	10/22/2020	For Verification	Low Risk	👁️ 💬			
☐	90122	👤	10/02/2020	10/02/2020	For Verification	No Case Assessment	👁️ 💬			
☐	90117	👤	10/02/2020	10/02/2020	For Verification	No Case Assessment	👁️ 💬			
☐	90116	👤	10/01/2020	10/01/2020	For Verification	No Case Assessment	👁️ 💬			
☐	90115	👤	10/01/2020	10/01/2020	For Verification	No Case Assessment	👁️ 💬			





My Workplace

Surveillance

Workplace Setup

### Personnel Health Declaration Submissions Today (Aggregated Self-Reports)

Add Filter

0 filters added

Case ID

Searching by: Case ID

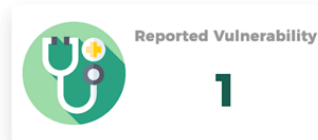

KC ID	Name	Workplace	Workbase Today	Reported Today	Temperature	Symptoms	Vulnerability	Exposure	Actions
97136	Test, Kira (workplace)	AI4GOV Bakeshop - Makati Branch	WFH	YES 41 minutes ago	NONE	NO	NO	NO	...
98812	TESRA, TESTETRES	AI4GOV Bakeshop - Makati Branch	Office	YES 2 hours ago	37°C	YES	YES	YES	...
98817	TESRST, TTEST	AI4GOV Bakeshop	Office	YES	37.5°C	YES	NO	NO	...

Personnel with linked kira accounts can send their symptoms, unit monitor can see the consolidated reports

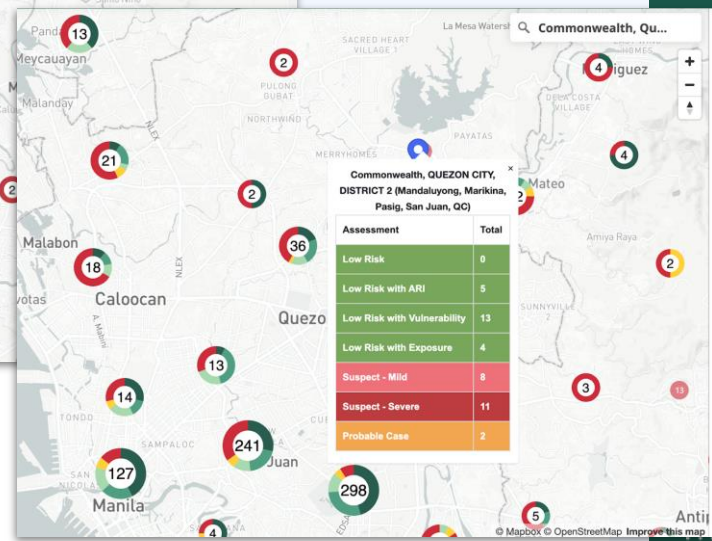
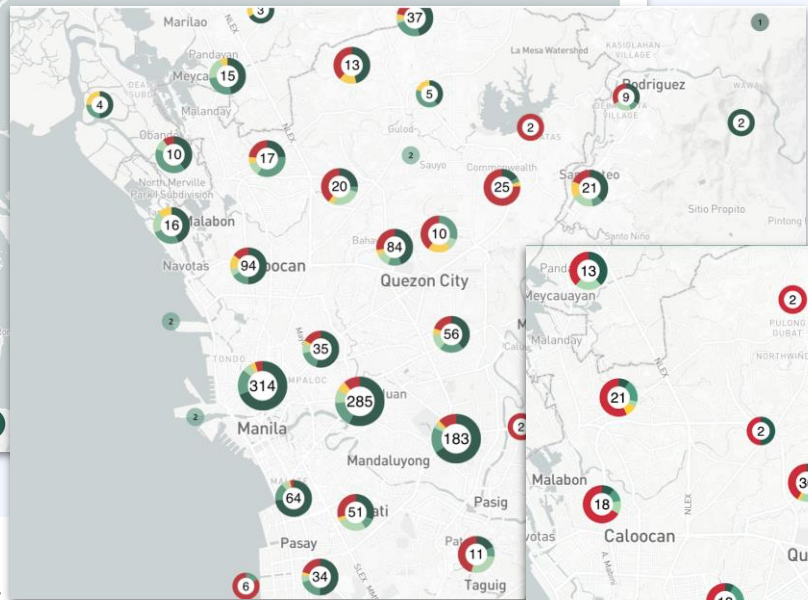
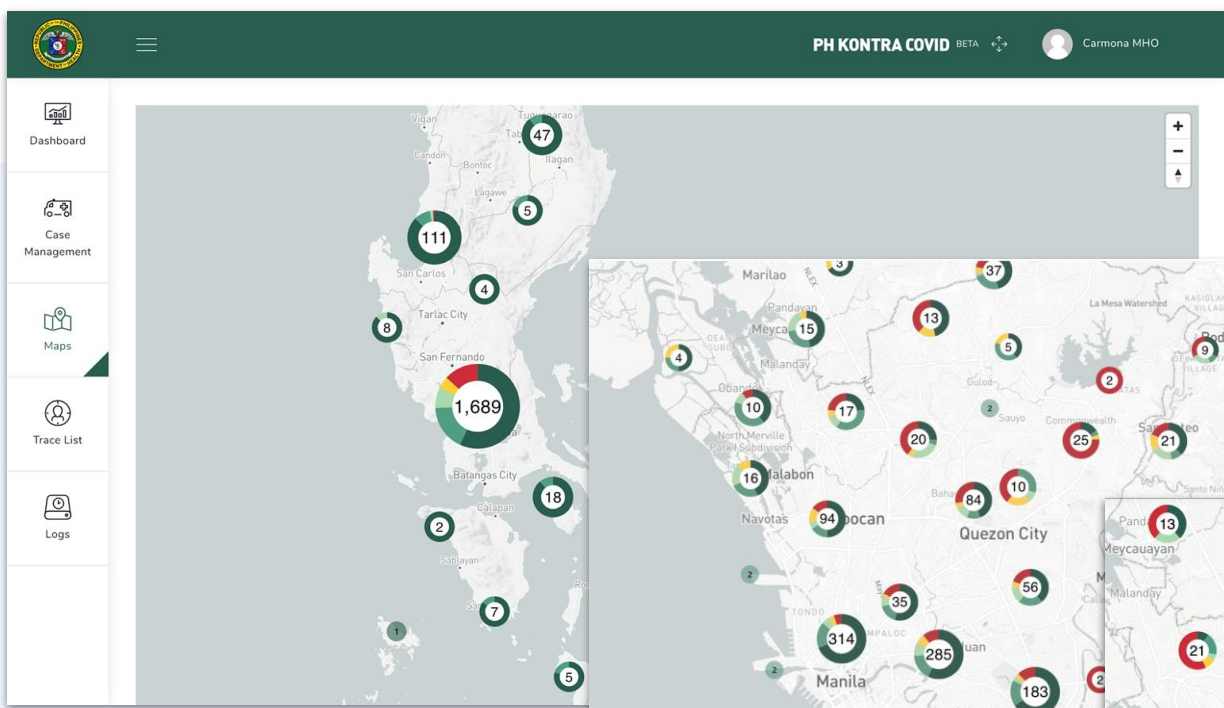

✓ Map feature with barangay-level provisional classification summaries

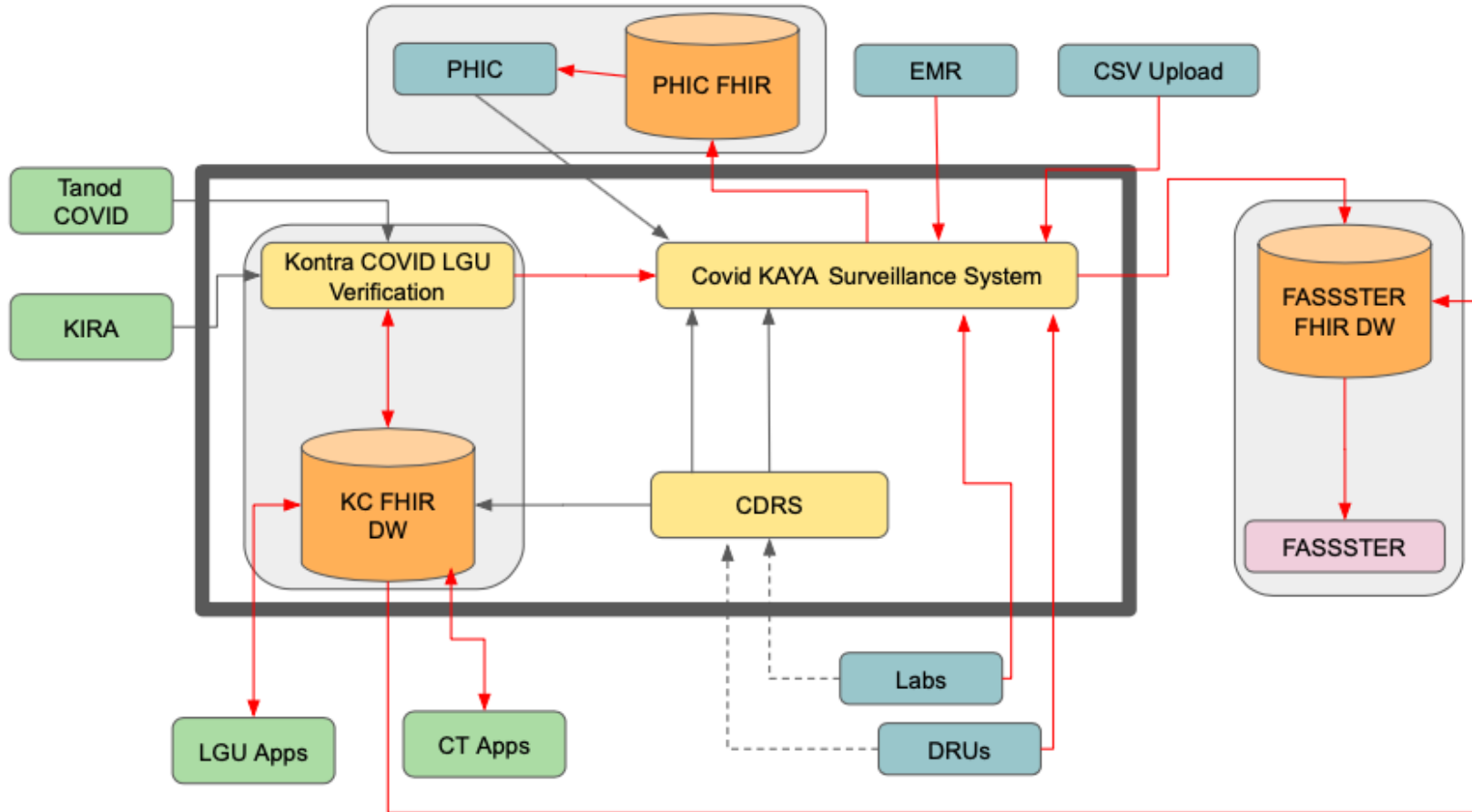

# Tanod-KontraCOVID stats

(Lifetime: April 23 - October 25)



~657K

Kira subscribers

~257K

Site visits

~18M

Interactions

71,243

self-checks conducted

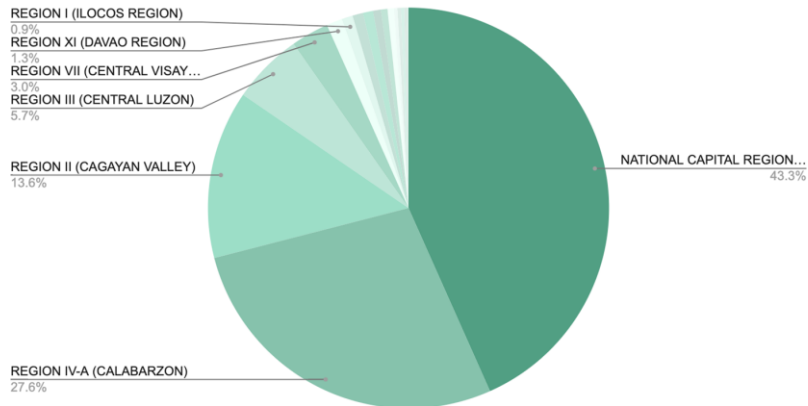

## LGUs with most number of citizen reports

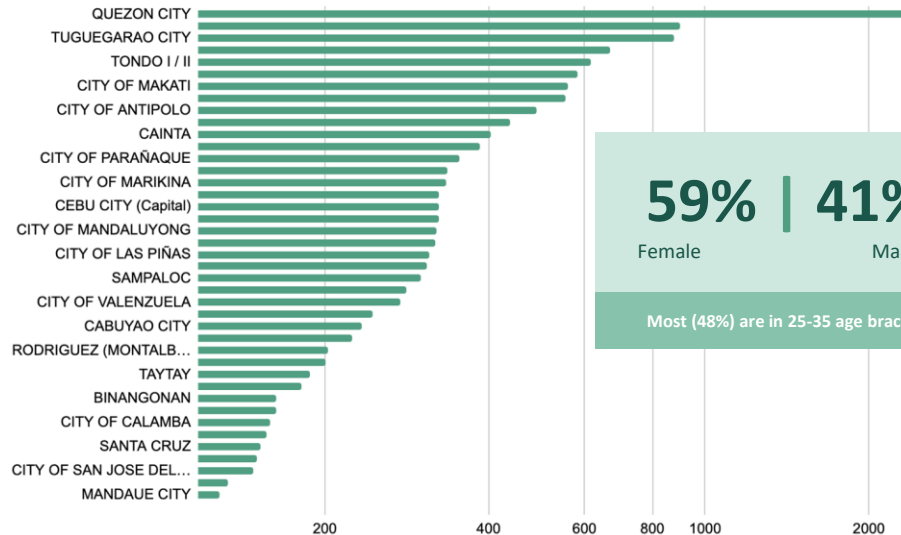

59% | 41%

Female

Male

Most (48%) are in 25-35 age bracket

52%

Reported  
Mild symptoms

40%

Reported Exposure

34%

Suspect Case  
(provisional assessment)