



**Supporting Platform Promotes 4IR Achievement**

# CONTENT

---

- 01** Introduction of our company
- 02** Our supporting platform SimColn
- 03** Working in traditional industry
- 04** Working in intelligent city construction
- 05** Current problems and future chance



01

**Introduction of our company**

# Introduction of our company



- Established in 1988, as one of first batch of key high-tech enterprises of China' s national Torch Program
- Simulation control & information system engineering
- National simulation & system control engineering tech R&D center
- Simulation control system manufacturer with the most R&D capability and influence in Asia



# Introduction of our company



## We are building two national technological innovation platforms

- National Simulation Control Engineering Technology Research Center, approved by ministry of science and technology.
- Comprehensive simulation modeling technology and supporting technology service platform, approved by NDRC.
- We have passed ISO2000 and TUV certification.

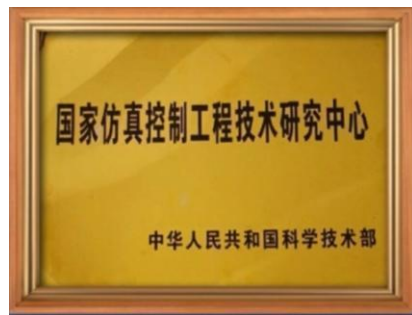

# Introduction of our company



Our company has always received the attention and guidance of Chinese national leaders.

More than 100 leaders, including Deng Xiaoping, Jiang Zemin, Hu Jintao and Wu Bangguo came to our company to inspect and guide our work.



Deng Xiaoping inspected and guided our company on 25th, Jan, 1992

# Introduction of our company



## • Business and projects areas

### Simulation systems

Electric power simulator

Thermal power

Nuclear power

Hydropower

Substation and power grid

Aircraft simulator

Navigation simulator

Traffic simulator

Chemical system simulator

Motion simulator

Decision system simulator

Economic simulator

Others

300 more

### Control systems

Real time data accessing system

Naibor system

Environmental control

Power plant monitoring

Online decision

Others

40 more

### Three in one systems

Digital power plant

Digital cement plant

Digital steel iron plant

Industrial big data application

Internet of things

Intelligent cities

30 more

### Information systems

Power plant informationize

Condition based maintenance

Large scale info management

Others

100 more

### Science and education

Science & Tech museum design

VR simulation

Visual management

Others

100 more



02

**The supporting platform SimCoIn**



# Supporting Platform SimColn



- The integrated platform SimColn (科英) we developed has three in one of simulation, control and information. It is the basis for the realization of various functions as online monitoring, online simulation and online decision.

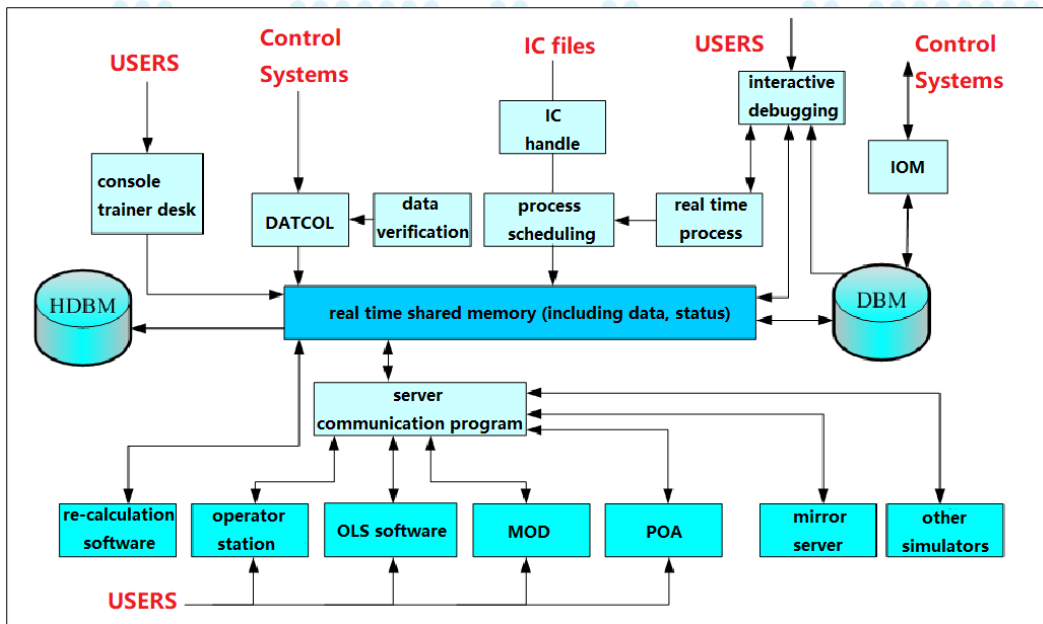

- three in one
- real time, history database
- development, commissioning, operation
- simulation modeling
- data collecting
- real time calculation
- communication server
- visual tools

# Supporting Platform SimColn



**We developed industrial real time database with completely independent intellectual property rights. It has the advantages of simple data interface and high operation efficiency.**

Excellent performances of SimColn real time database:

- Unlimited total memory points
- Max memory points of a single global area:200k
- Speed of real time value query:280k points/sec
- Speed of history database query:30k records/sec
- Historical data storage compression ratio:40:1



# Supporting Platform SimColn



## Interactive operation on the platform (power plant)

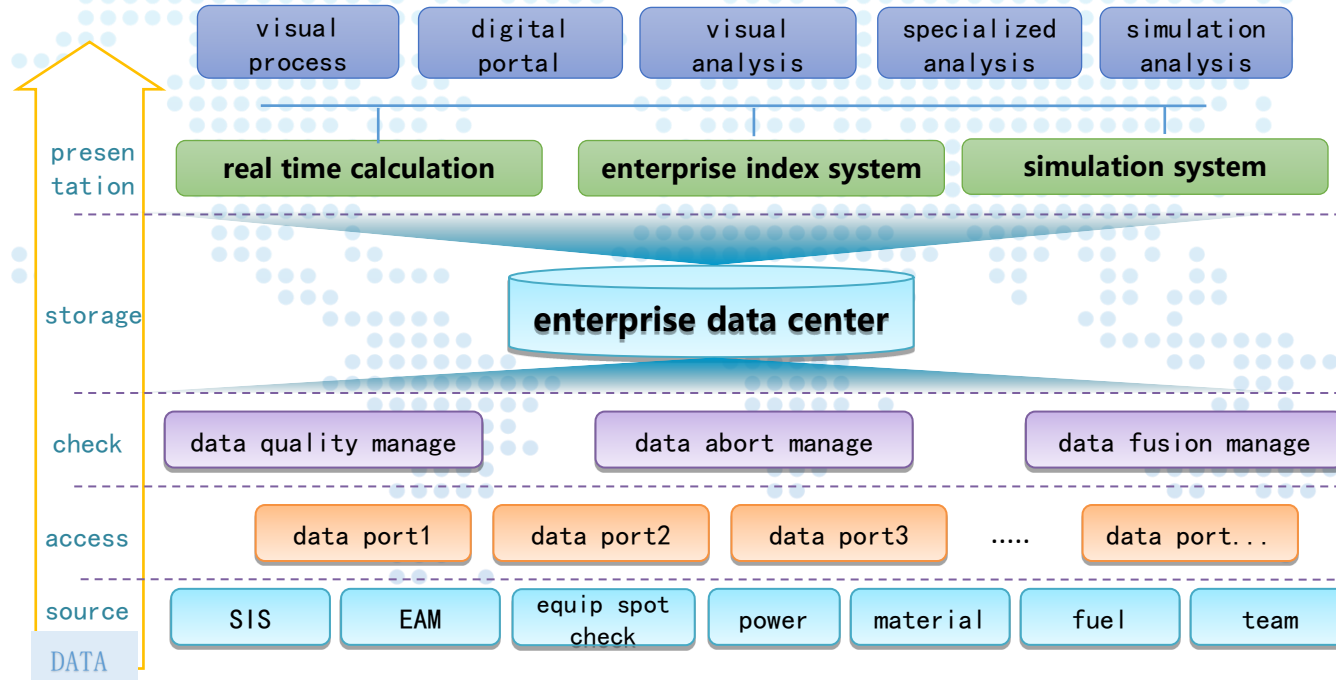



03

**Working in traditional industry**

# Working in traditional industry



**Revolution does not mean abandoning traditional and old industries. Yet, 4IR will bring them new life by injecting them with new ideas and technologies.**

Difficulties and problems faced by iron and steel plants:

- Data and information isolation
- Manufacture procedure delays
- Little remote monitoring and management capability
- None of online decision tools and AI analysis
- Excessive energy consumption and carbon emissions
- Excessive unnecessary operating costs



**Transformation & upgrading project with integration of industrialization and digitization**

# Working in traditional industry



SimColn supporting platform acting as foundation, industrial big database can be built, then more practical functions and applications are supplied such as real time monitoring, data analysis, online decision system.

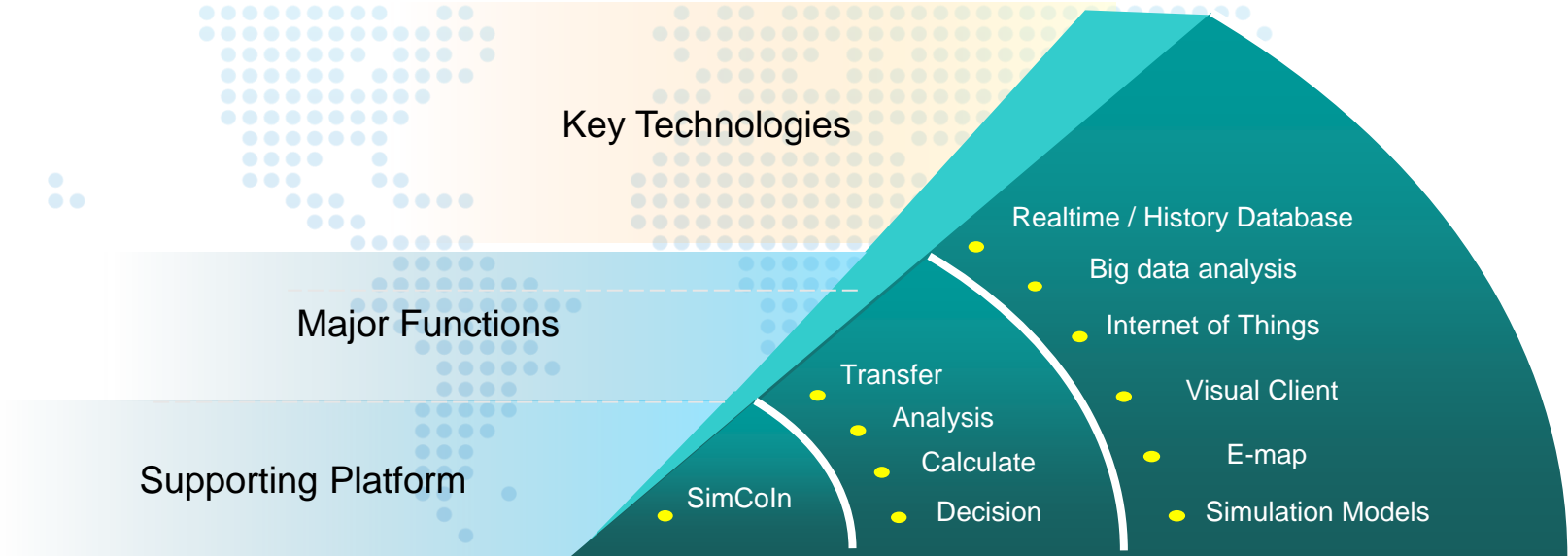

# Working in traditional industry



To build a big industrial database, manage servers by levels so as to realize data collection, storage and processing centrally.

- real time data collection (more than 220k information points)
- DCS systems simulators (269 sub systems)
- removal of potential risk (more than 1k Gas detectors)
- secure storage (test data of molten iron and steel)
- energy management (E-M center and power control center)
- environmental monitoring (more than 80 emission detectors)

# Working in traditional industry

Real time simulators provide visual, alertable, traceable and analyzable manufacture procedure.

炼铁工序运行监控

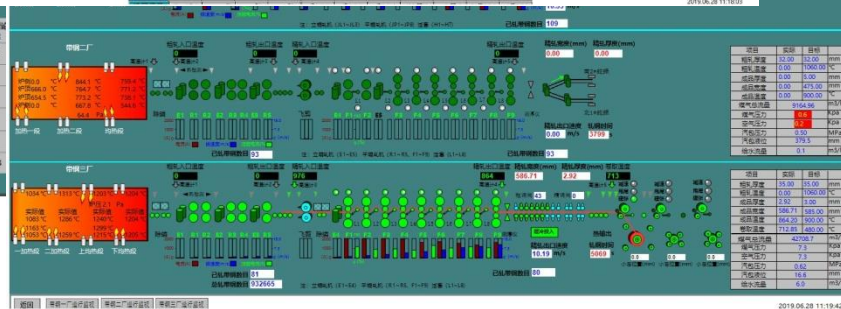
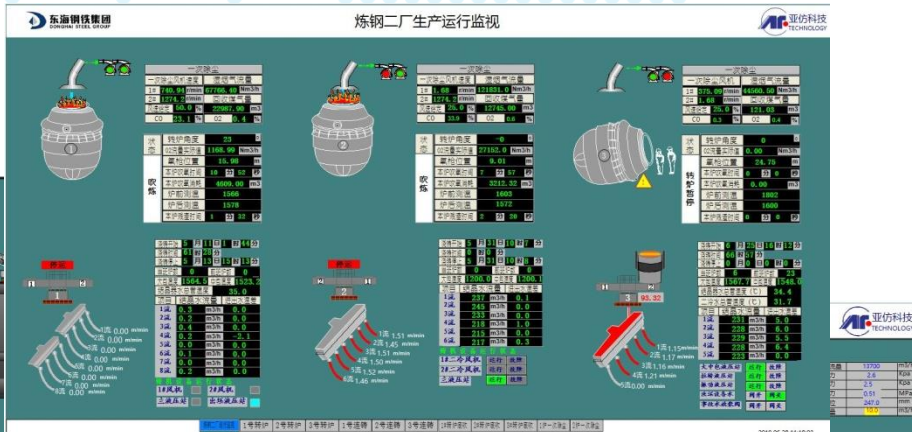
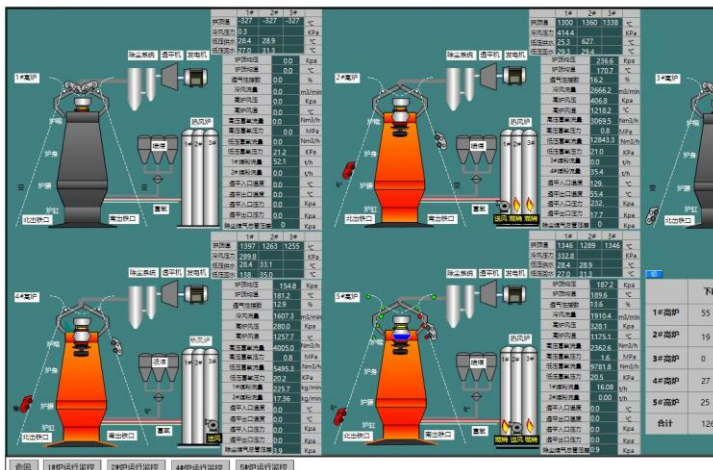



# Working in traditional industry



We have developed an integrated on-line optimal scheduling system for energy production, and it improves the energy balance prediction and production scheduling capability.

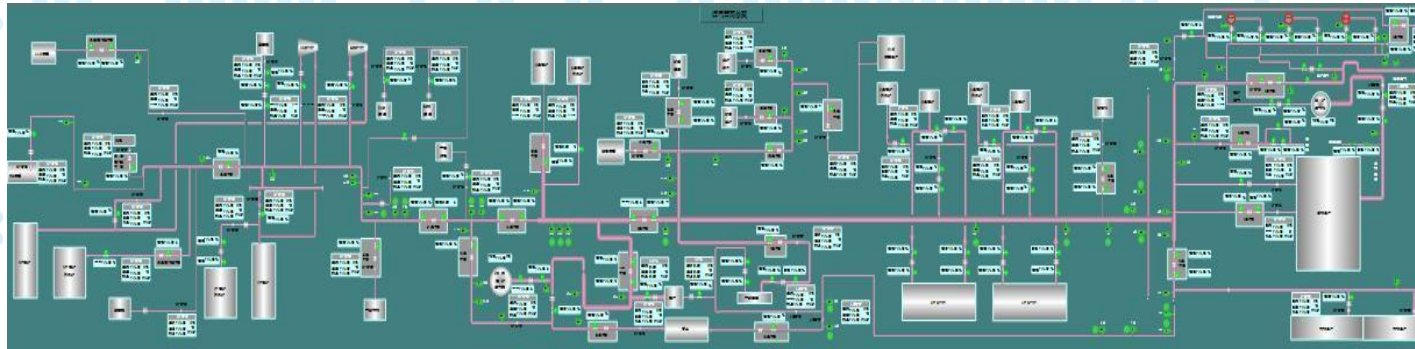

**GAS pipe network digital management**

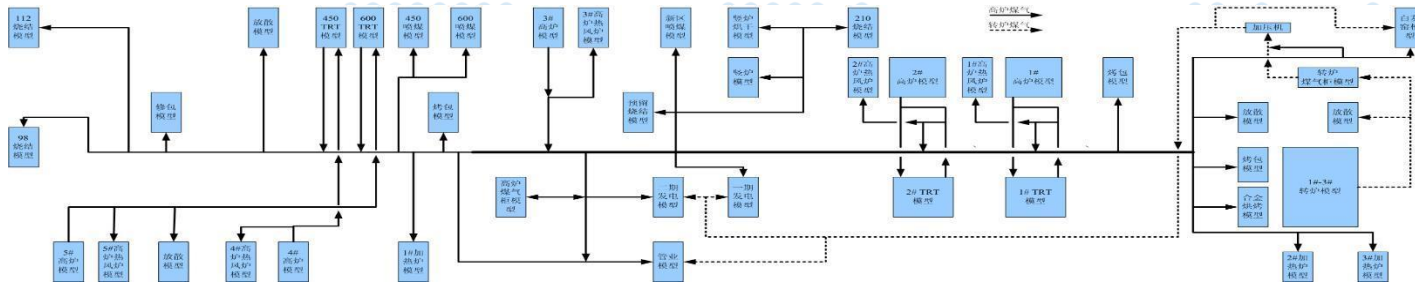

# Working in traditional industry



Optimized dispatching of compressed air by energy pipe network model and P-C unit model.

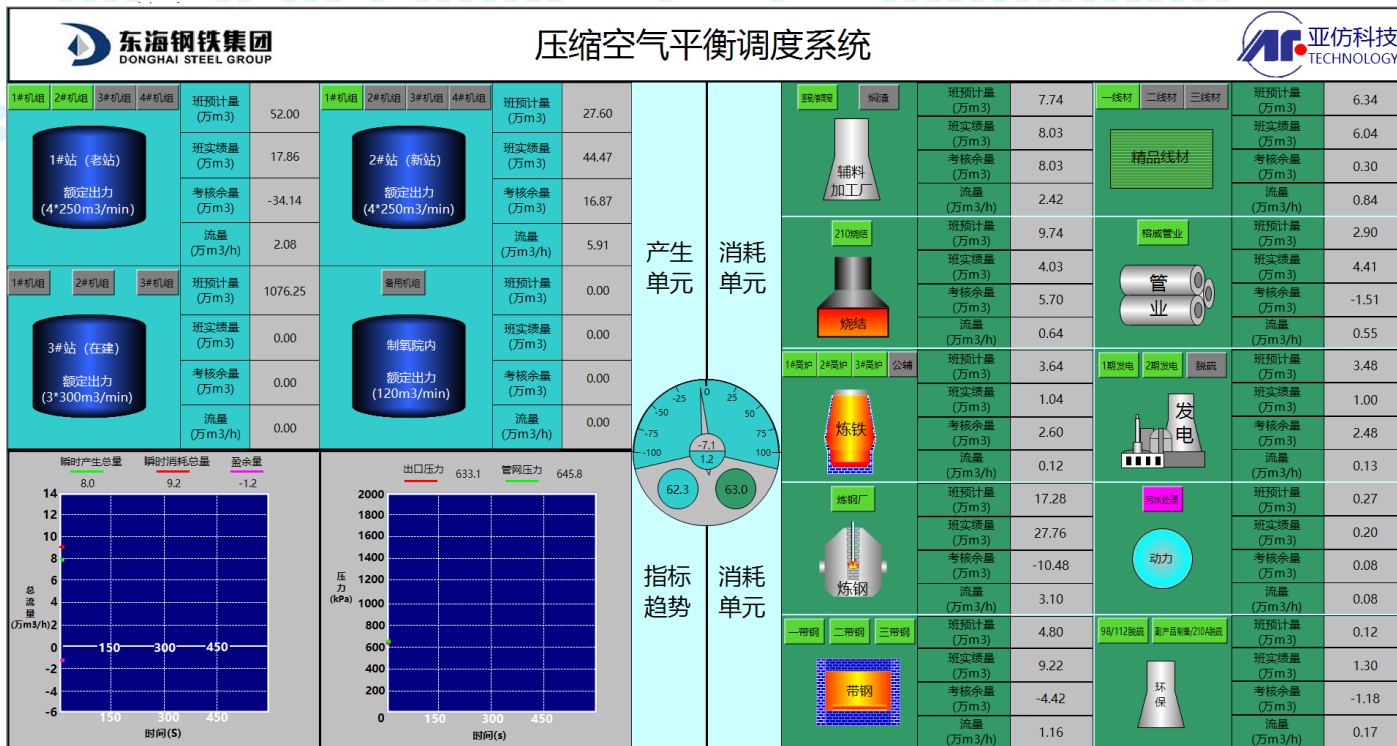

# Working in traditional industry

## Compressed Air

## Power equipment monitoring:

- data from PLC
- running status
- start/stop records
- key parameter
- set alarms
- trend analysis

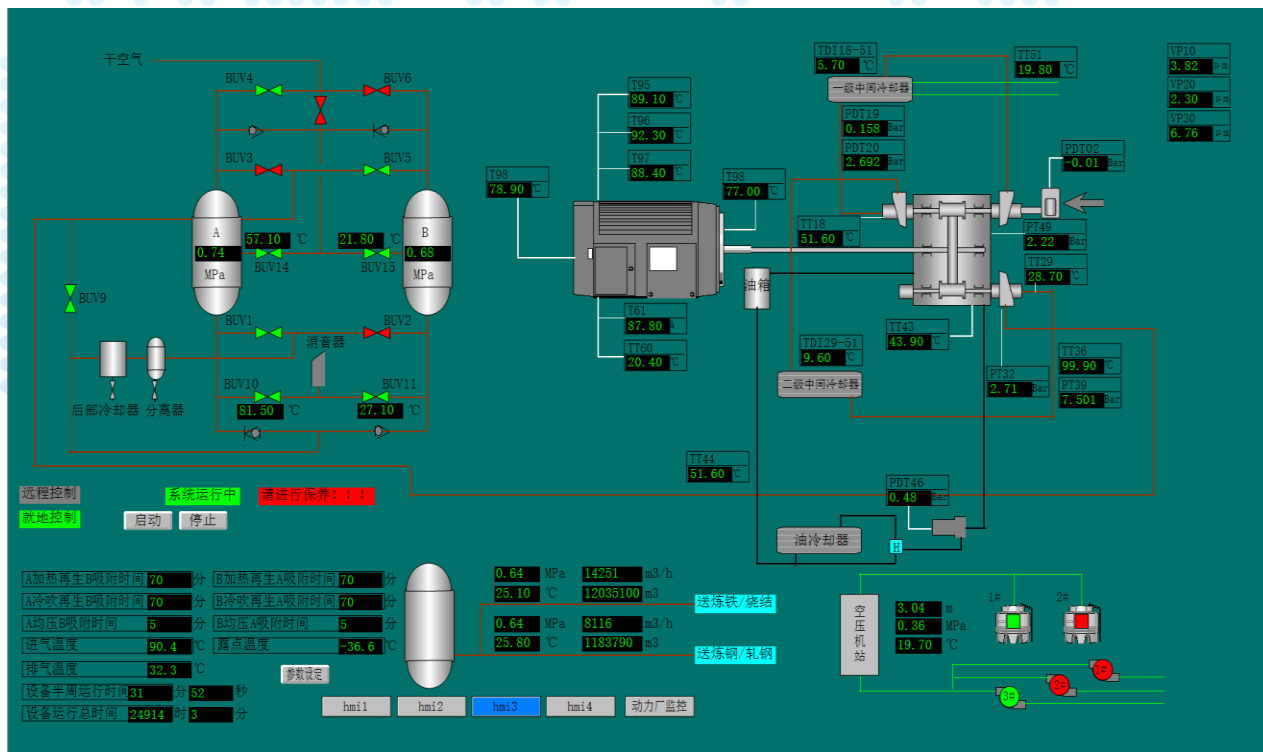

# Working in traditional industry



## Online monitoring of gas leakage

- Using electronic map and wireless transmission technology.
- Centralized monitoring and early warning including more than 1000 spots.
- Linkage between intercom system and video monitoring system.

发电厂煤气泄漏分析报表 (低报: 大于160 高报: 大于2000 故障: 大于2000)								
序号	名称	数值	序号	名称	数值	序号	名称	
1	一期化学北侧转煤排水器	0	16	一期发电锅炉八米加药间	0	31	1#锅炉高炉煤气平台	0
2	一期炉后0米高煤排水器	2	17	一期发电东电子间右	0	32	1#锅炉转炉煤气平台	0
3	一期外网总管高煤排水器	0	18	一期发电控制室右	0	33	1#发电管道层	0
4	一期锅炉0米右高煤排水器	0	19	一期发电东电子间左	6	34	备用	0
5	一期锅炉0米左高煤排水器	5	20	一期发电西电子间	8	35	锅炉上层燃燃器区域B	0
6	一期锅炉0米转煤排水器	4	21	一期发电控制室左	10	36	锅炉0米区域左前CO含量	0
7	二期化学南侧转煤排水器	7	22	一期发电交接班室二	0	37	锅炉0米区域右前CO含量	3
8	二期北侧外网高煤排水器	0	23	一期发电八米交接班室	0	38	锅炉0米区域左后CO含量	2
9	二期炉后混合器排水器	4	24	预警	0	39	锅炉0米区域右后CO含量	0
10	二期化水控制室	0	25	1#锅炉左前角	0	40	会议室内煤气含量	1
11	一期八米锅炉房左边	7	26	1#锅炉左后角	0	41	主控室内左CO层	5
12	一期八米锅炉房右边	0	27	1#锅炉右前角	0	42	交接班室内CO层	4
13	一期发电除盐水冷却间	0	28	1#锅炉右后角	0	43	锅炉上层燃燃器区域A	0
14	一期发电锅炉阀门配电室	0	29	1#锅炉右侧下	0	44	锅炉上层燃燃器区域C	0
15	一期发电锅炉八米取药间	0	30	1#锅炉左侧下	0	45	锅炉上层燃燃器区域D	0

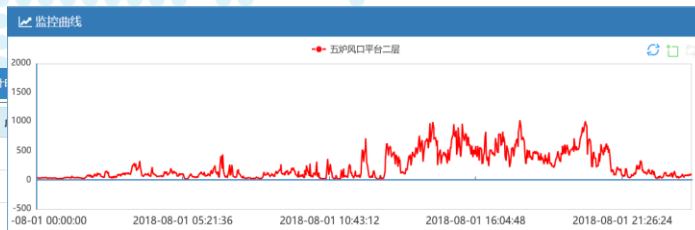

序号	名称	数值
49	锅炉下层燃燃器区域B	0
50	高炉煤气阀门操作平台A	0
51	高炉煤气阀门操作平台B	0
52	转炉煤气阀门操作平台	0
53	混合煤气阀门操作平台	0
54	主厂房电缆夹层	0
55	主厂房集中控制室	1
56	主厂房电子设备间	1
57	煤气加热器平台A	0
58	煤气加热器平台B	0

# Working in traditional industry

## Electronic map for monitoring gas leakage point



# Working in traditional industry



## We have established a centralized dispatching center

- It realizes centralized monitoring and unified scheduling of production, energy, safety, environmental protection and process, greatly improves the timeliness and rationality of plant level dispatching.





04

**Working in intelligent city construction**

# Working in intelligent city construction



AF' s Values of Intelligent City:  
More scientific development, more efficient management and better life

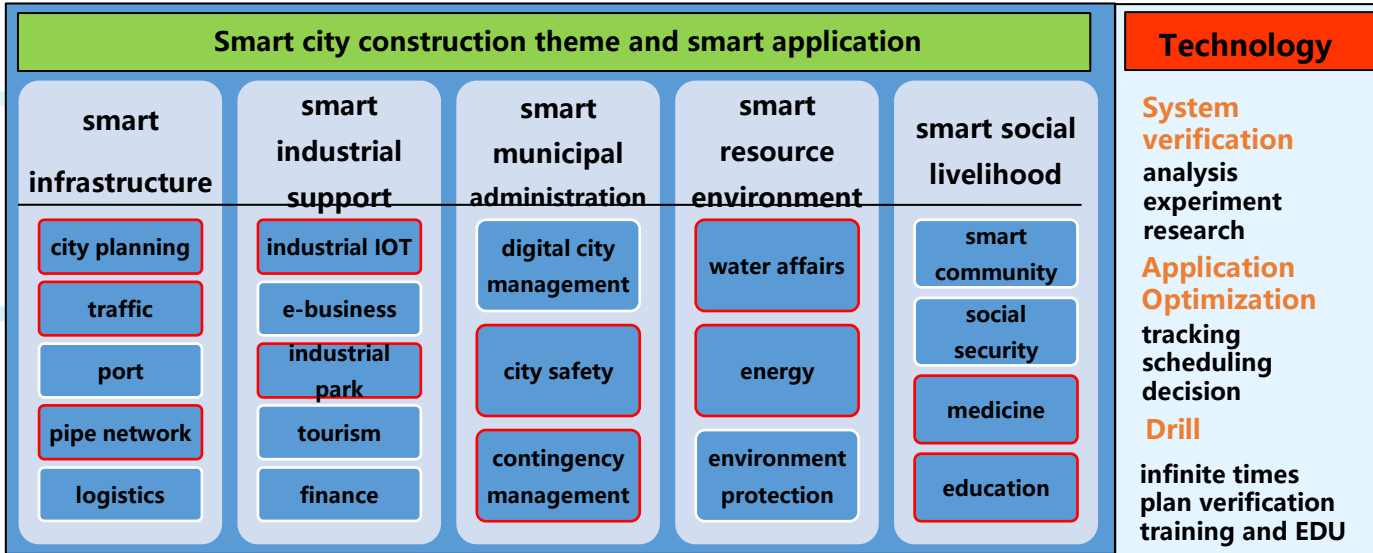

perception integration cloud-calculation automatic disposal

Simulation, control, information 3in1 supporting platform: SimColn



# Working in intelligent city construction



The scope of urban emergency events includes:

- Public health emergencies
- Extreme weather like typhoon, rainstorm
- Conflagration
- Social unrest
- Nuclear accident
- .....

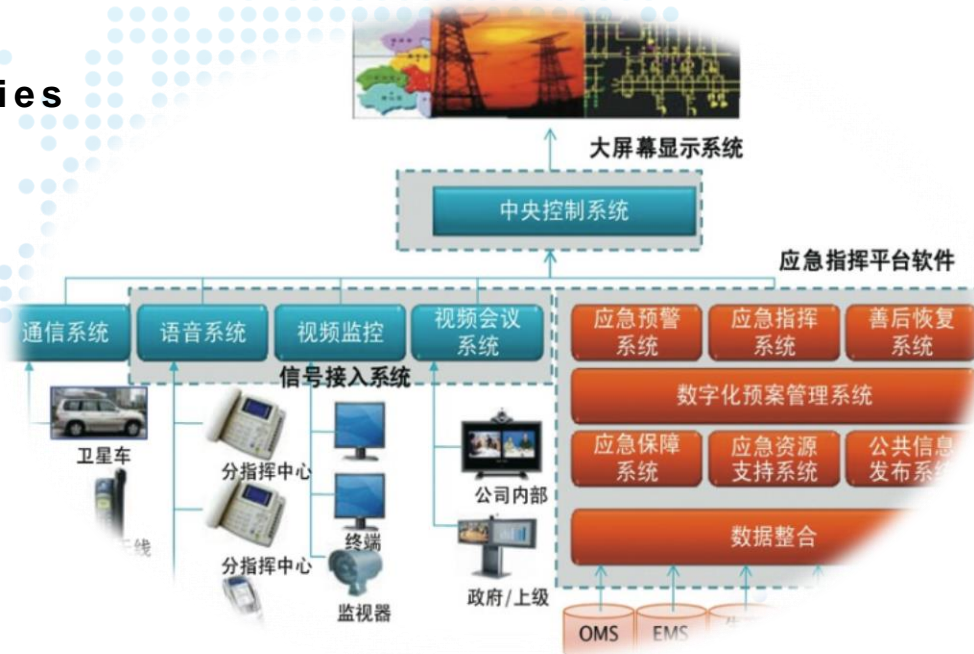

# Working in intelligent city construction



## Urban waterlogging simulation and decision support system

- Real time monitoring and early warning
- History replay and analysis
- Pre plan drill and analysis
- Dynamic prediction and scheduling

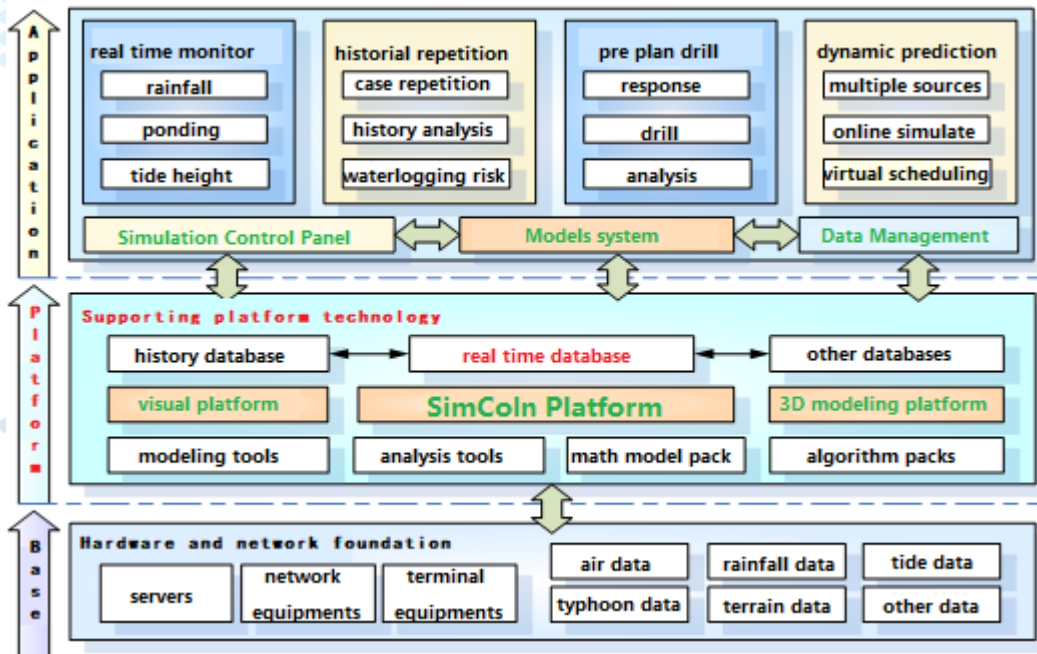

# Working in intelligent city construction



## Real time monitoring and early warning:

- **Integrating monitoring data of meteorology, water affairs, airports, ports, etc.** To realize centralized monitoring and management of all useful data.
- **Combine the radar temporary forecast, monitoring data and numerical simulation technology to obtain more accurate real time early warning conclusion of waterlogging.**

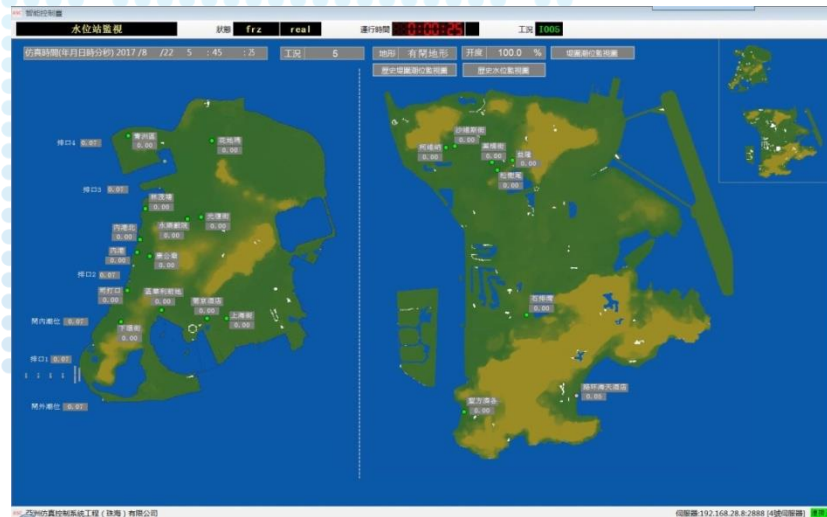

# Working in intelligent city construction

## Numerical simulation model of urban waterlogging:

- Complex urban terrain can be characterized more precisely by irregular (several types of size) grid.
- Surface hydrodynamic simulation
- Urban drainage network simulation
- Coupling models

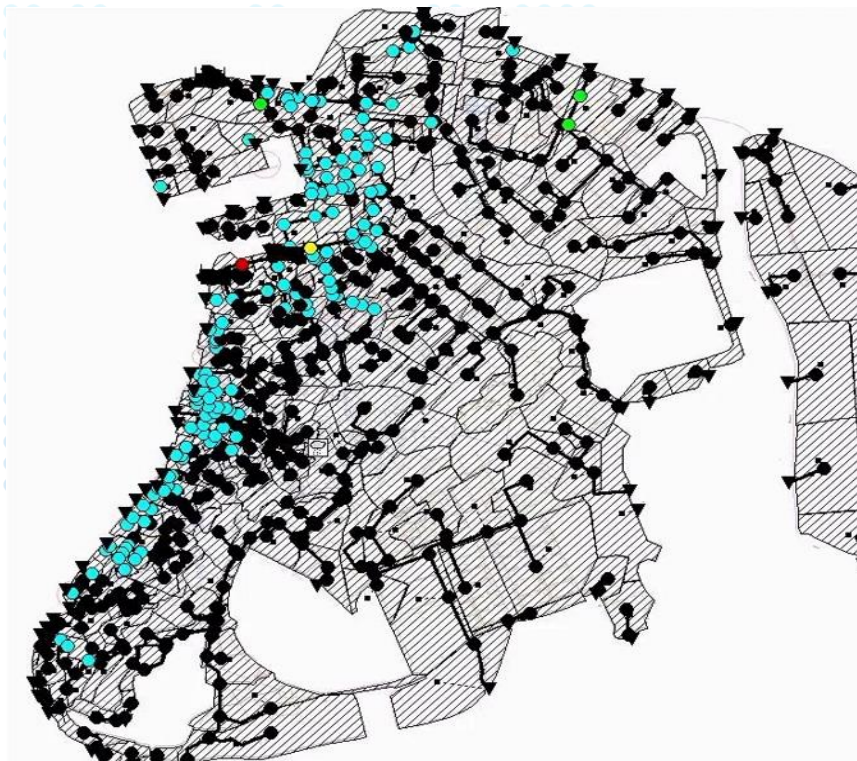

# Working in intelligent city construction



## History replay and analysis:

- Simulation replay of historical typical rainstorm cases.
- AI and big data analysis technology are used to analyze the spatiotemporal distribution characteristics of urban rainfall and ponding.
- Based on historical analysis, the urban waterlogging risk assessment map was established.

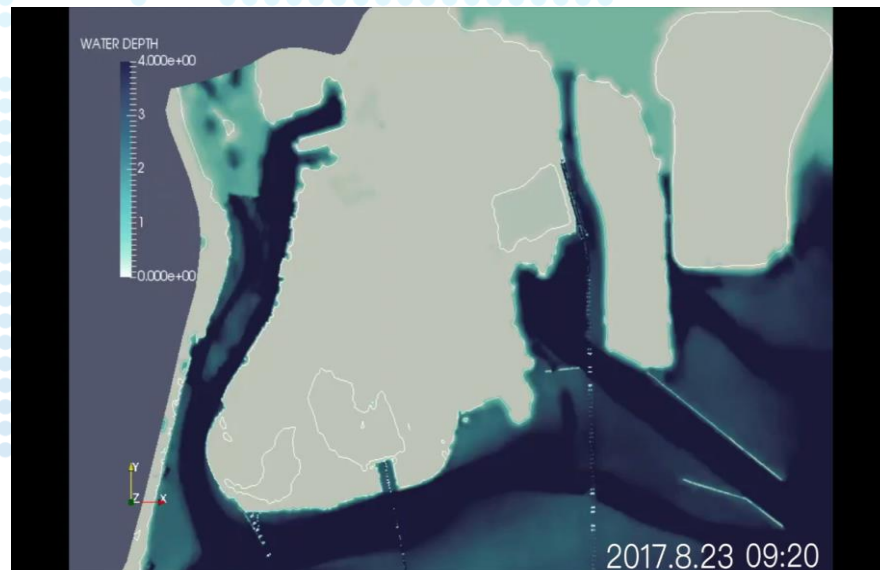

Repeat of the flooding process  
Typhoon Hato(2017) in Macao

# Working in intelligent city construction

By Repeating of the flooding process during Typhoon Hato(2017), our simulation results are consistent with the statistics results of official departments. The flooding area of Macao Peninsula is mainly concentrated in the coastal area of the inner port of the peninsula.

NO.	Max Value time	Measured data	Simulation data	Error rate
1	2017/08/23 12:20	3.4 Km <sup>2</sup>	3.37 Km <sup>2</sup>	0.88%

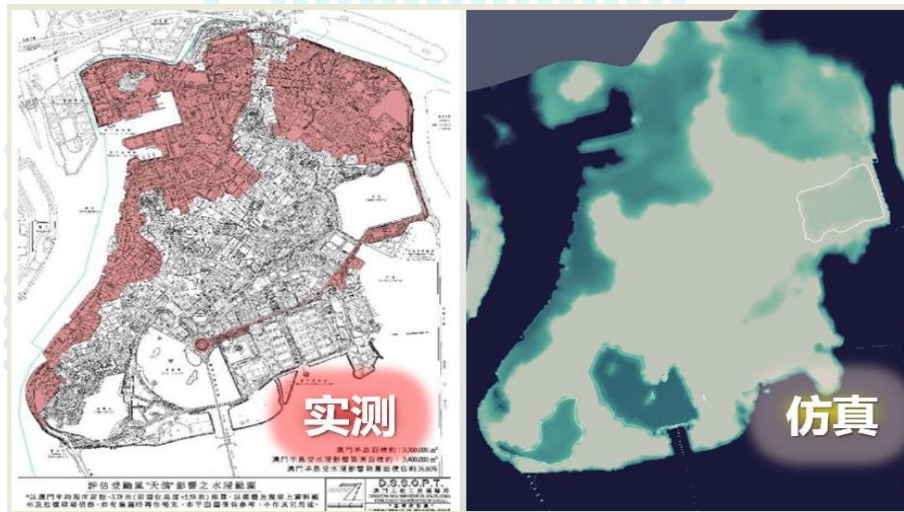

Left: Official statistics result  
Right: Simulation result

# Working in intelligent city construction



## Drilling and analysis of waterlogging emergency plan:

- Establish emergency plan analysis model to realize intelligent management of emergency plans.
- The multi-agent technology is adopted to establish the coordinated operation model of multi-departments for urban waterlogging emergency, so as to realize the deduction and joint drill of urban emergency plan.
- Based on the simulation results of the emergency plan, to improve the allocation of various resources.

# Working in intelligent city construction

## Prediction of waterlogging based on AI:

- Combine neural network model with hydrologic and hydrodynamic model to realize the prediction of urban waterlogging process.
- The predicted results are more accurate than the measured monitoring data.
- The calculation speed is faster, which effectively solves the problem of timeliness of urban waterlogging early warning.

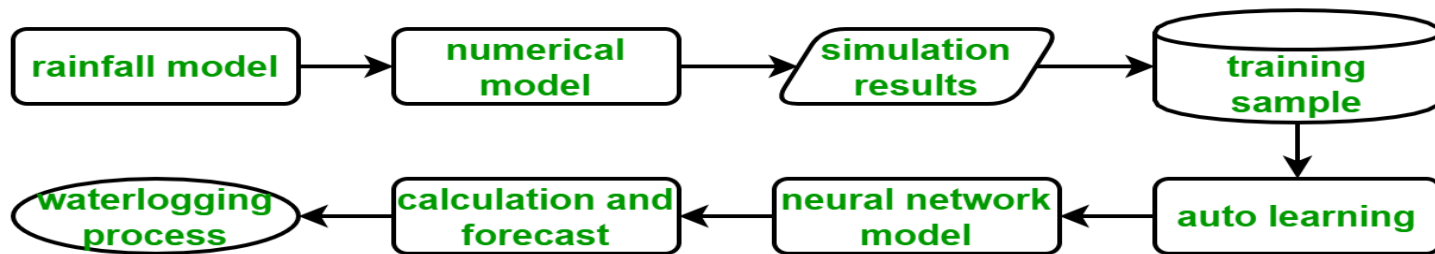





05

**Current problems and future chance**

# Current problems and future chance



## Problems:

- Due to some reasons, such as technical closed loop, the data interface cannot be unified so far. It seriously delays the data interaction time between different support platforms, which also indirectly affects the overall achievement of 4ir.
- Lack of digital and information infrastructure.
- The contradiction between universality and customization of auto-learninges.

## Chances:

- It is an important strategy for many countries and regions to use excellent support platforms to help enterprises realize digital reform, which is conducive to the leapfrog development of the Asia Pacific region economy.
- It drives talent reserve and technical exchange. Almost all industries can achieve upgrading and transformation via 4ir core technology.



Thanks for listening